

# PINCE DE TRI

# MB-G450 S4

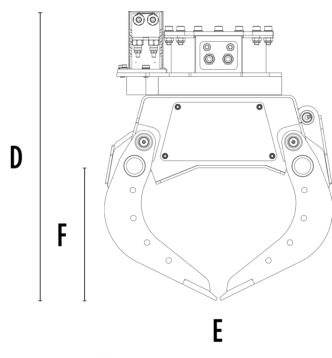

## CARACTÉRISTIQUES TECHNIQUES

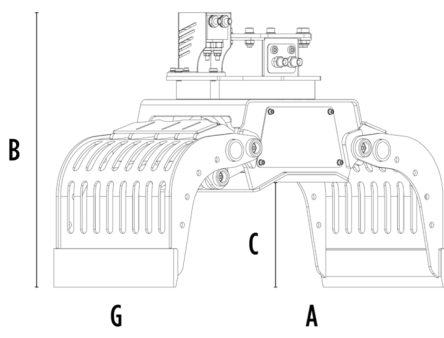

Pelle hydraulique recommandée	lb	7,720 - 12,120
Poids	lb	635
Capacité (griffes fermées)	cy	0.13
Rotation	Degree	360°
Pression d'huile (rotation)	PSI	2,176 - 2,901
Débit d'huile (rotation)	gal/min	3 - 5
Pression d'huile maximale (ouverture - fermeture)	PSI	2,611 - 3,191
Débit d'huile maximum (ouverture - fermeture)	gal/min	5 - 8
Dimension A	in	51
Dimension B	in	34
Dimension C	in	17
Dimension D	in	38
Dimension E	in	30
Dimension F	in	20
Dimension G	in	19

## OPTIONS

Kit de lames multifonctions	Kit benne preneuse
Kit plaque latérale dentée	Kit amélioration préhension interne
Kit soulèvement basculant avec profils en caoutchouc	Kit inverseur électrique (nécessaire pour pelle ayant 1 seule ligne) 12 V

## DOMAINES D'APPLICATION



Démolitions



Travaux routiers



Tunnels



Lieux clos



Canalisations



Chantiers urbains



Entretien des espaces  
verts et agricoles



Entretien des zones  
forestières