

Technical data

Power supply	24V DC
Current	0.3 A
Maximum power consumption	7.2 W
Insulation class	III
Connection	8 m IMMERSION CABLE 2X0.75
Beam angle	95°
Number of LEDs	3
LED color	COLD WHITE
Total luminous flux	790 lm
Body	AISI316L STEEL, GLASS
Weight	0.8 kg
Protection rating	IP68
Working conditions	EXCLUSIVELY IN THE WATER
Maximum ambient temperature	MAX +40 °C

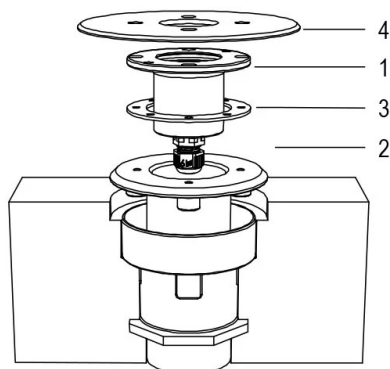

LED fountain lamp with fixed color, ideal for medium-small installations. Available with various optics to illuminate pools or jets of different shapes. Nozzle provided for recessed installation in concrete.



1. LAMP
2. INLET FITTING
3. GASKET
4. FRONT FLANGE

Related documentation:

Manuale utente IT:

Certificato CE IT:

User manual EN:

CE certification EN:

