

PINÇA SELECIONADORA MB-G1200 S4

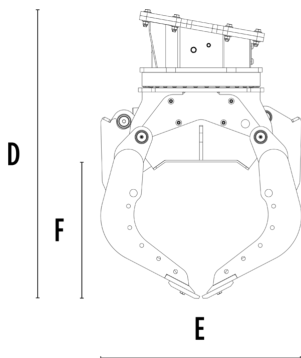
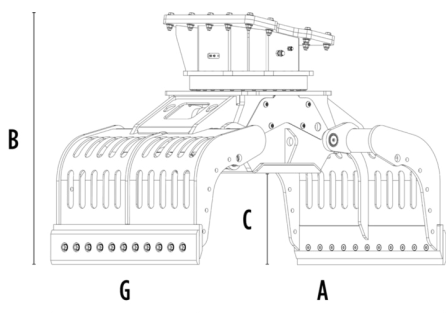

CARACTERÍSTICAS TÉCNICAS

Escavadora recomendada	ton	18 - 30
Peso	ton	1,65
Capacidade (garras fechadas)	m ³	0,71
Rotação	Grau	360°
Pressão do óleo (rotação)	bar	200 - 250
Fluxo de óleo (rotação)	l/min	30 - 40
Pressão máxima de óleo (abertura - fechamento)	bar	300 - 350
Fluxo máximo de óleo (abertura - fechamento)	l/min	70 - 90
Dimensão A	mm	2115
Dimensão B	mm	1450
Dimensão C	mm	590
Dimensão D	mm	1670
Dimensão E	mm	1185
Dimensão F	mm	810
Dimensão G	mm	1235

ACESSÓRIOS OPCIONAIS EXTRAS

Kit de lâminas multifunções	Kit de cobertura contenção de garras
Kit de melhoria do aperto das garras internas	Kit elevador inclinado com perfis de borracha
Kit multiplicador de força de rotação	Kit de desviador elétrico (função de duas mangueiras) 12 V
Remote power control system	

ÁREAS DE APLICAÇÃO



Demolições



Obras rodoviárias



Pedreiras



Minas



Túneis



Ambientes fechados



Canalizações



Estaleiros urbanos



Manutenção de áreas verdes e agrícolas



Manutenção de áreas florestais

