

CORALLO 3

LAMP WITH 8m of CABLE

Cod.3509380393

CORALLO 3 WHITE 10° 5000K



Fixed-color LED fountain lamp with high optical efficiency. Available with various optics to illuminate fountains with jets of different shapes and sizes. Bracket allows installation in any position.

Technical data

Power supply	24V DC
Current	2.5 A
Maximum power consumption	55 W
Insulation class	III
Connection	8 m BLUE PBS-POOL CABLE 2X2.5
Beam angle	10°
Number of LEDs	12
LED color	COLD WHITE
Total luminous flux	5200 lm
Body	AISI316L STEEL, GLASS
Weight	3.1 kg
Protection rating	IP68
Working conditions	EXCLUSIVELY IN THE WATER
Maximum ambient temperature	MAX +40 °C

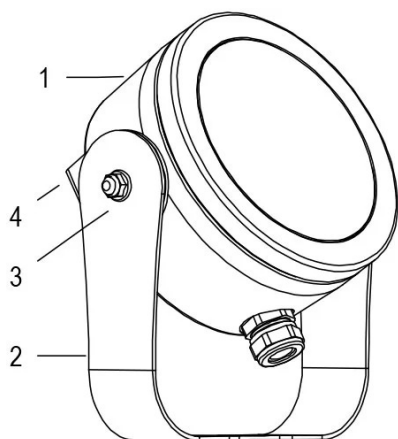

1. LAMP
2. MOUNTING BRACKET
3. TILT FRICTION
4. LAMP SUPPORT

Related documentation:

Manuale utente IT:

Certificato CE IT:

User manual EN:

CE certification EN:

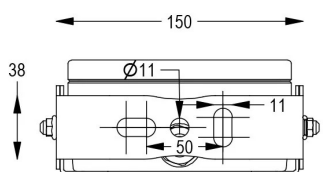
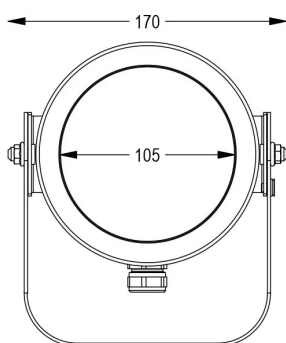
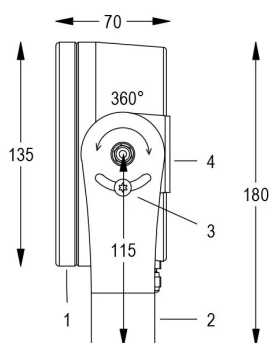

RGBW DMX 2x4mm² + DMX

WHITE FIX 2x2.5mm²

14/10/2024 - The data in this document may be changed without notice in order to improve the product or to correct any errors.