

SORTING GRAPPLE

MB-G900 S4

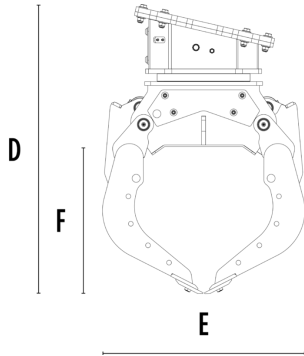
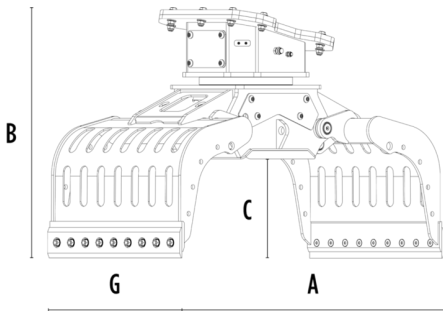

SPECIFICATIONS

Recommended excavator	lb	26,460 - 39,680
Weight	lb	1,72
Capacity (claws closed)	cy	0.56
Rotation	Degree	360°
Oil pressure (rotation)	PSI	2,321 - 3,191
Oil flow rate (rotation)	gal/min	4 - 9
Maximum oil pressure (opening - closing)	PSI	4,351 - 5,076
Maximum oil flow rate (opening - closing)	gal/min	16 - 18
Size A	in	73
Size B	in	48
Size C	in	21
Size D	in	56
Size E	in	39
Size F	in	29
Size G	in	37

OPTIONAL ACCESSORIES

Multi-purpose blade kit	Clam shell kit
Serrated side plate kit	Grip improvement kit
Rubber protection kit	Rotation power extender kit
Electrical kit (for 2 hose functionality) 12 V	Remote power control system

APPLICATION AREAS



Demolitions



Road works



Quarry



Mines



Tunnels



Enclosed spaces



Pipelines



Urban construction site



Maintaining landscape and agricultural areas



Forest Maintenance

