

Poldina

Sembri nata dalle terre umide
mentre la vicina laguna
risplende del finire del sole.
Piccola, illumini
in un contrasto concreto e voluto
gli arbusti selvaggi e profumati.

You appear to have come from the wetlands
while the nearby lagoon
glows in the setting sun.
Little one, you illuminate
with a distinct, intentional contrast
wild and fragrant shrubs.

TAVOLO / MINI TAVOLO / MICRO TAVOLO / L DESK TAVOLO / L TERRA-TAVOLO / XXL TERRA-TAVOLO / PICCHETTO / SOSPENSIONE /
PARETE / ACCESSORI
TABLE LAMP / MINI TABLE LAMP / MICRO TABLE LAMP / L DESK TABLE LAMP / L FLOOR-TABLE LAMP / XXL FLOOR-TABLE LAMP /
LAMP WITH PEG / SUSPENSION LAMP / WALL LAMP / ACCESSORIES



Poldina lamp with peg white
→ **LD0282B3**
Porto Caleri
Rovigo, Italy



Previous page:
Poldina table lamp white → **LD0340B3**
Poldina table lamp dark grey → **LD0340N3**

Current page: Poldina XXL floor-table
lamp dark grey → **LD0360N3**
Linder Cycling Hotel - Bolzano, Italy
Photo Tiberio Sorvillo

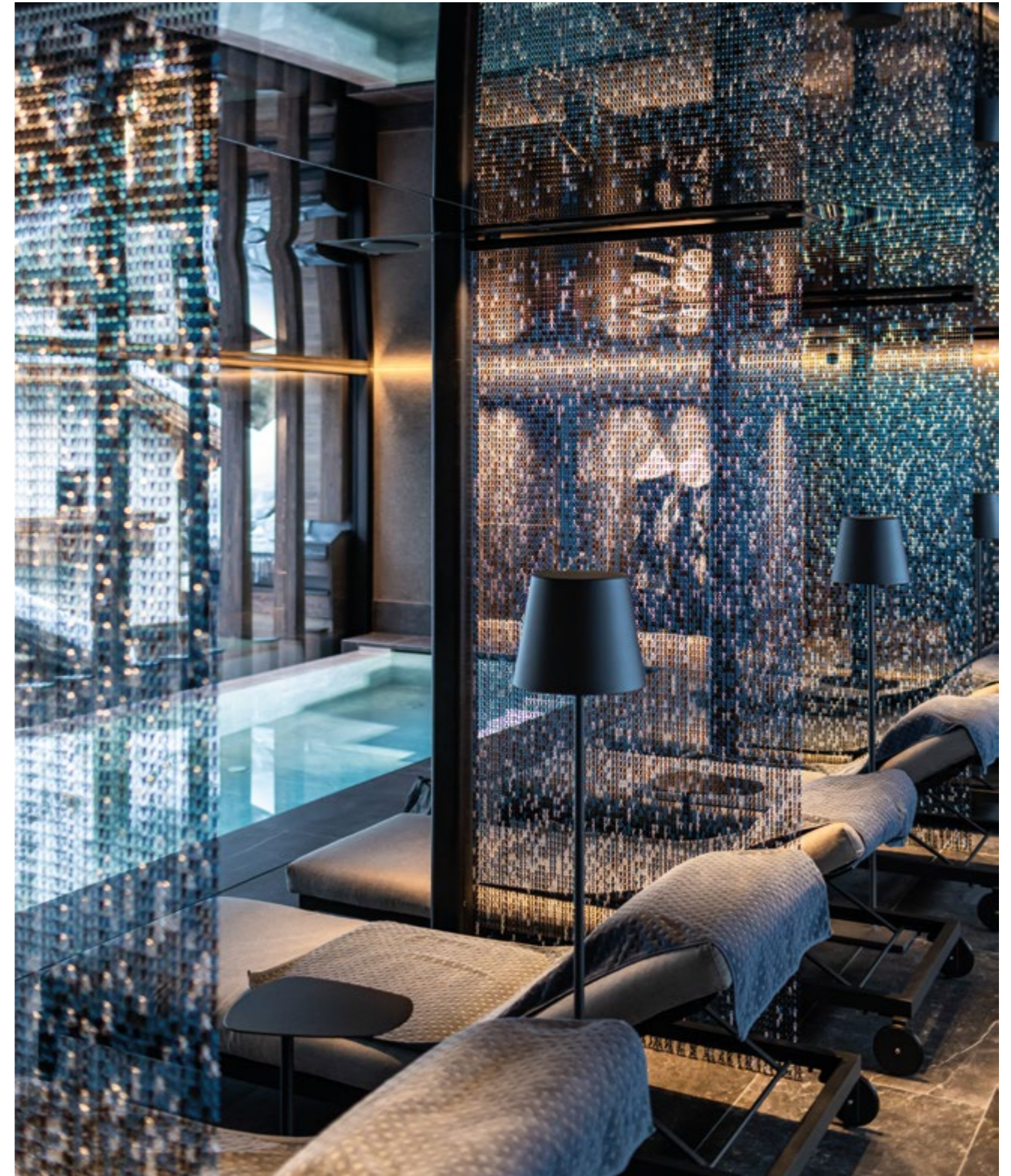



Current page: Poldina table
lamp corten → **LD0340R3**
Natu Restaurant, Athens
Greece

Arch. Photography Giorgos Sfakianakis

Next page: Poldina mini
table lamp white → **LD0320B3**
Gran Caffè Quadri, Piazza San Marco
Venice, Italy

Photo Maurizio Torresan Photographer

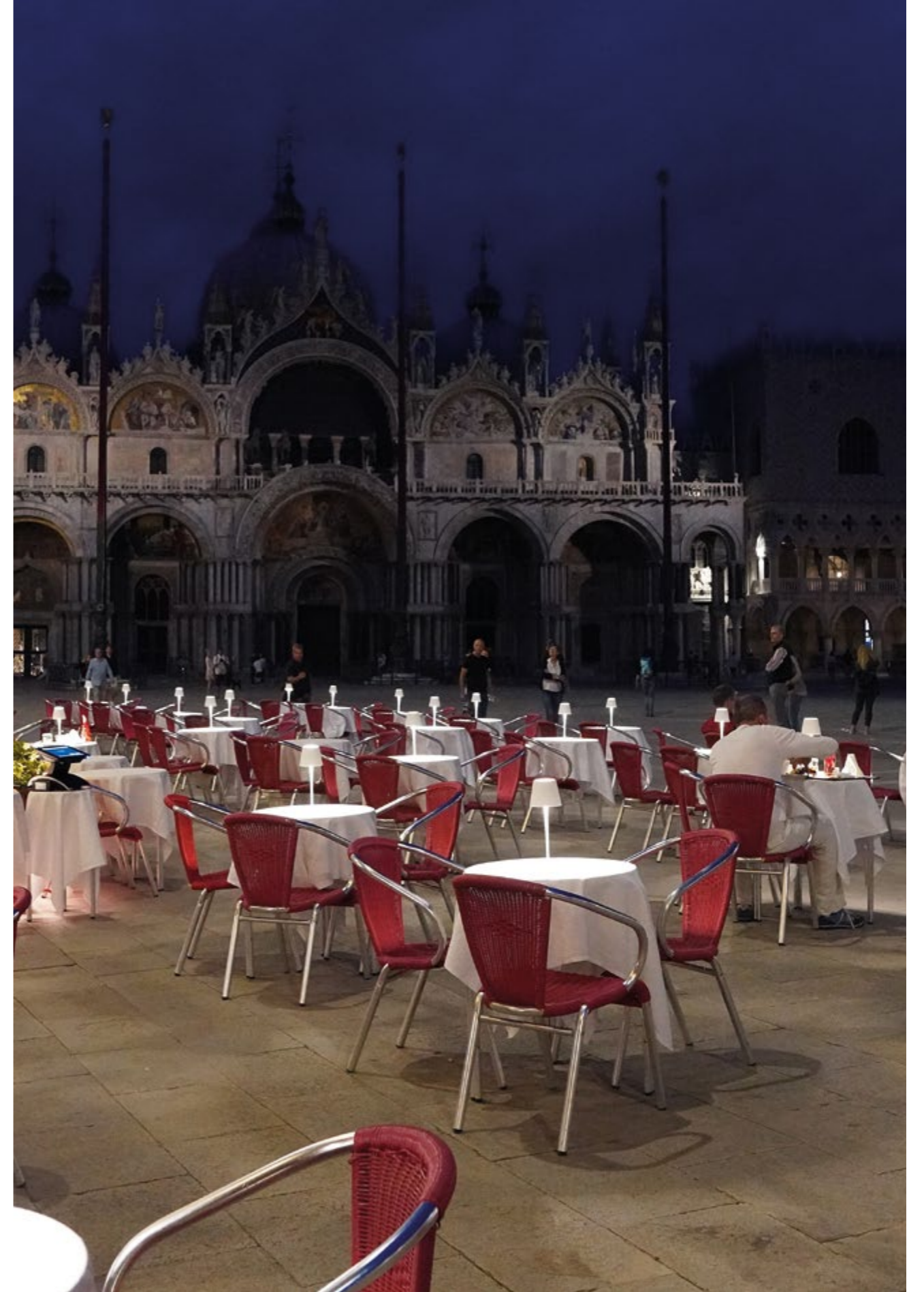

Poldina

Tavolo pro Table lamp pro

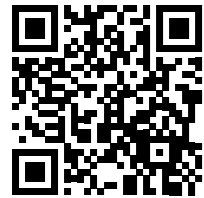

Video Poldina



Poldina è una lampada da tavolo a batteria, portatile e ricaricabile. Nella parte superiore della testa è presente un controllo "touch", che permette l'accensione, la regolazione dell'intensità luminosa e la selezione della temperatura di colore della luce tra 2200K, 2700K e 3000K. Grazie a un alto indice di protezione, la lampada è utilizzabile anche all'esterno (ad eccezione dei modelli con finitura a foglia metallica e finitura galvanica, delle quali è sconsigliato l'uso continuativo in esterni). Possiede un sistema di controllo elettronico che monitora e segnala l'autonomia residua della batteria, permettendo di ottimizzare le ricariche ed effettuarle sempre in maniera corretta. È dotata di base di ricarica a contatto; caricabatterie incluso. È possibile personalizzare la lampada con cover in ceramica, acquistabili separatamente (pag. 54).

Poldina is a rechargeable battery-powered cordless table lamp. A "touch" control on the head allows switching on/off, dimming, and selecting the color temperature of the light (2200K, 2700K or 3000K). It is suitable for both indoor and outdoor use (except gold, silver, and copper finishes). An electronic control system monitors the remaining autonomy and ensures a constant luminous flux until the battery runs out. Recharging is therefore optimized and always properly done. Poldina comes with a contact charging base; the battery charger is included. The lamp can be customized with a ceramic cover, to be purchased separately (pg. 54).

Dati tecnici Technical data

LED TOUCH DIMMER | 100-240V | 2200-2700-3000K | CRI>80 | 50-60Hz | 2,2W | 234-251-256lm | **IP65** | 5Vdc max 1A

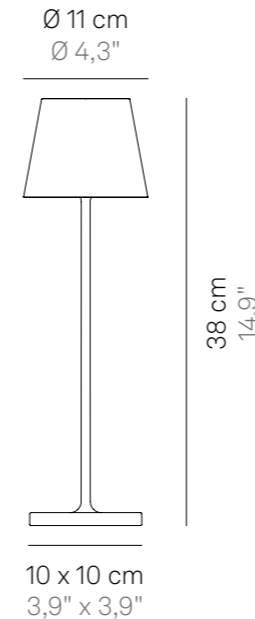

9,4 x 9,4 cm
3,7" x 3,7"

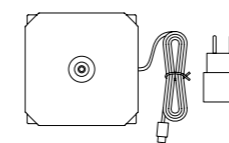

Componenti inclusi Components included

Base di ricarica a contatto
Contact charging base
Caricabatterie
Charger

Corpo in pressofusione di alluminio verniciato
Painted die-cast aluminum body

Schermo diffusore in policarbonato
Polycarbonate diffuser

Adatta all'uso esterno (lampada IP65) e interno (lampada su base di ricarica IP20) → legenda pag. 208
Suitable for outdoor (lamp IP65) and indoor use (lamp on charging base IP20) → legend pg. 208

Durata di circa 12 h alla massima potenza
Battery lasts about 12 h at full power

Tempo di ricarica a 1A: 6/7 h
Charging time at 1A: 6/7 h

Pacco batteria al litio ricaricabile e sostituibile
Rechargeable and replaceable lithium battery pack

Avvertenze Remarks

Le lampade con finitura foglia color oro, foglia color argento e foglia color rame e con finitura galvanica lucida oro e cromo non sono adatte per uso esterno. The lamps with gold color leaf, silver color leaf and copper color leaf finish and with gold and chrome glossy galvanic finish are not suitable for outdoor use.

Per effetto della natura manuale della tecnica adottata nella lavorazione con foglia metallica, l'aspetto finale della finitura delle lampade può risultare differente. Eventuali difformità attestano il pregio e l'unicità di ciascuna lampada e non vanno considerate come imperfezioni. Due to the manual nature of the technique adopted in the application of the metal foil, the final appearance of the lamps' finishing can be different. Any apparent imperfections attest to the quality and exclusivity of each lamp and should not be considered as imperfections.

Finiture
Finishes



LD0340B3
Bianco / White
RAL 9003

LD0340R3
Corten

LD0340N3
Grigio scuro / Dark grey

LD0340S3
Sabbia / Sand



LD0340X3
Bordeaux / Burgundy
RAL 3005

LD0340M3
Verde scuro / Dark green
RAL 6005

LD0340O3 *
Oro lucido
/ Glossy gold

LD0340C3 *
Cromo lucido
/ Glossy chrome

Finiture
Finishes



LD0340G3
Salvia / Sage green
Pantone 5635 U

LD0340A3
Blu avio / Avio blue
Pantone 7468 U

LD0340P3
Rosa / Pink
Pantone 698 U

LD0340F3
Rosso / Red
RAL 3000



LD0340BFO *
Foglia color oro
/ Gold color leaf

LD0340BFA *
Foglia color argento
/ Silver color leaf

LD0340RFR *
Foglia color rame
/ Copper color leaf

* Le lampade con finitura galvanica lucida oro e cromo non sono adatte per uso esterno e sono dotate della funzione di selezione della temperatura di colore della luce tra 2700 K e 3000 K.

* The lamps with gold and chrome glossy galvanic finish are not suitable for outdoor use and they are equipped with a light color temperature selection function 2700 K or 3000 K.

* Le lampade con finitura foglia color oro, foglia color argento e foglia color rame non sono adatte per uso esterno.
* The lamps with gold color leaf, silver color leaf and copper color leaf finish are not suitable for outdoor use.

poldina x PEANUTS

Tavolo pro
Table lamp pro



Poldina x Peanuts è l'edizione speciale di Poldina, lampada da tavolo a batteria portatile e ricaricabile, personalizzata con i personaggi creati da Charles Schulz. Peanuts, la striscia creata da Charles Schulz e pubblicata dal 1950, è uno dei fumetti più conosciuti al mondo. Poetici, teneri e ironici, i suoi personaggi sono figure classiche e senza tempo, in cui ogni lettore può riconoscersi.

Poldina x Peanuts is a special edition of the rechargeable battery-powered cordless table lamp Poldina, customized with characters created by Charles Schulz. Peanuts, first published in 1950, is one of the best-known comic strips in the world. Each member of the Peanuts gang is a classic, timeless figure with whom every reader can identify.

Poldina x Peanuts table lamp
Aviator → **LD0340FP1**



Dati tecnici

Technical data

LED TOUCH DIMMER | 100-240V | 2200-2700-3000K | CRI>80 | 50-60Hz | 2,2W | 234-251-256lm | **IP65** | 5Vdc max 1A



Corpo in pressofusione di alluminio verniciato

Painted die-cast aluminum body

Schermo diffusore in policarbonato

Polycarbonate diffuser

Adatta all'uso esterno (lampada IP65) e interno (lampada su base di ricarica IP20) → legenda pag. 208

Suitable for outdoor (lamp IP65) and indoor use (lamp on charging base IP20) → legend pg. 208

Durata di circa 12 h alla massima potenza

Battery lasts about 12 h at full power

Tempo di ricarica a 1A: 6/7 h

Charging time at 1A: 6/7 h

Pacco batteria al litio ricaricabile e sostituibile

Rechargeable and replaceable lithium battery pack

Ø 11 cm
Ø 4,3"

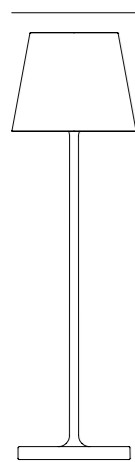

38 cm
14,9"

10 x 10 cm
3,9" x 3,9"

9,4 x 9,4 cm
3,7" x 3,7"

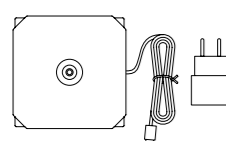
**Componenti inclusi**

Components included

Base di ricarica a contatto

Contact charging base

Caricabatterie

Charger

Finiture

Finishes

**LD0340FP1**

Aviator

RAL 3000

**LD0340BP2**

Heart

RAL 9003

**LD0340BP3**

Friends

RAL 9003

**LD0340BP4**

Strip

RAL 9003

**LD0340RP5**

Together



Poldina mini

Tavolo pro Table lamp pro



Poldina mini è una lampada da tavolo a batteria, portatile e ricaricabile. Nella parte superiore della testa è presente un controllo "touch", che permette l'accensione, la regolazione dell'intensità luminosa e la selezione della temperatura di colore della luce tra 2200K, 2700K e 3000K. Grazie a un alto indice di protezione, la lampada è utilizzabile anche all'esterno (ad eccezione dei modelli con finitura a foglia metallica e finitura galvanica, delle quali è sconsigliato l'uso continuativo in esterni). Possiede un sistema di controllo elettronico che monitora e segnala l'autonomia residua della batteria, permettendo di ottimizzare le ricariche ed effettuarle sempre in maniera corretta. È dotata di base di ricarica a contatto; caricabatterie incluso. È possibile personalizzare la lampada con cover in ceramica, acquistabili separatamente

Poldina mini is a rechargeable battery-powered cordless table lamp. A "touch" control on the head allows switching on/off, dimming, and selecting the color temperature of the light (2200K, 2700K or 3000K). It is suitable for both indoor and outdoor use (except gold, silver, and copper finishes). An electronic control system monitors the remaining autonomy and ensures a constant luminous flux until the battery runs out. Recharging is therefore optimized and always properly done. Poldina comes with a contact charging base; the battery charger is included. The lamp can be customized with a ceramic cover, to be purchased separately

Dati tecnici Technical data

LED TOUCH DIMMER | 100-240V | 2200-2700-3000K | CRI>80 | 50-60Hz | 2,2W | 234-251-256lm | **IP65** | 5Vdc max 1A

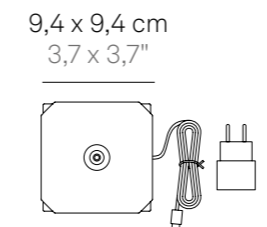
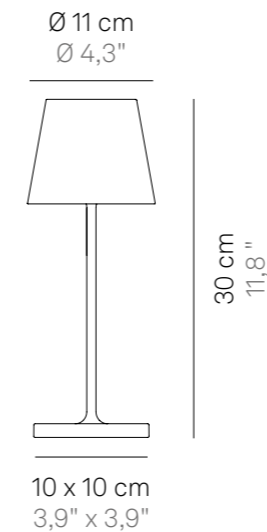

Corpo in pressofusione di alluminio verniciato
Painted die-cast aluminum body

Schermo diffusore in policarbonato
Polycarbonate diffuser

Adatta all'uso esterno (lampada IP65) e interno (lampada su base di ricarica IP20) → legenda pag. 208
Suitable for outdoor (lamp IP65) and indoor use (lamp on charging base IP20) → legend pg. 208

Durata di circa 12 h alla massima potenza
Battery lasts about 12 h at full power

Tempo di ricarica a 1A: 6/7 h
Charging time at 1A: 6/7 h

Pacco batteria al litio ricaricabile e sostituibile
Rechargeable and replaceable lithium battery pack

Avvertenze Remarks

Le lampade con finitura foglia color oro, foglia color argento e foglia color rame e con finitura galvanica lucida oro e cromo non sono adatte per uso esterno.
The lamps with gold color leaf, silver color leaf and copper color leaf finish and with gold and chrome glossy galvanic finish are not suitable for outdoor use.

Per effetto della natura manuale della tecnica adottata nella lavorazione con foglia metallica, l'aspetto finale della finitura delle lampade può risultare differente. Eventuali difformità attestano il pregio e l'unicità di ciascuna lampada e non vanno considerate come imperfezioni.

Due to the manual nature of the technique adopted in the application of the metal foil, the final appearance of the lamps' finishing can be different. Any apparent imperfections attest to the quality and exclusivity of each lamp and should not be considered as imperfections.

Componenti inclusi Components included

Base di ricarica a contatto
Contact charging base
Caricabatterie
Charger

Finiture
Finishes



LD0320B3

Bianco / White
RAL 9003

LD0320R3

Corten

LD0320N3

Grigio scuro / Dark grey

LD0320S3

Sabbia / Sand

Finiture
Finishes



LD0320BFO *

Foglia color oro
/ Gold color leaf

LD0320BFA *

Foglia color argento
/ Silver color leaf

LD0320RFR *

Foglia color rame
/ Copper color leaf



Poldina mini table
lamp dark grey
→ **LD0320N3**



LD0320O3 *

Oro lucido
/ Glossy gold

LD0320C3 *

Cromo lucido
/ Glossy chrome

* Le lampade con finitura foglia color oro, foglia color argento e foglia color rame e con finitura galvanica lucida oro e cromo non sono adatte per uso esterno. Le finiture cromate sono dotate della funzione di selezione della temperatura di colore della luce tra 2700 K e 3000 K.

* The lamps with gold color leaf, silver color leaf, copper color leaf finish and with gold and chrome glossy galvanic finish are not suitable for outdoor use. The lamps with glossy finish are equipped with a light color temperature selection function 2700 K or 3000 K.

Poldina micro

Tavolo pro Table lamp pro



Premio Barawards 2022
Innovazione dell'Anno

Barawards 2022 Innovation
of the Year Award



Poldina micro è una lampada da tavolo a batteria, portatile e ricaricabile. Nella parte superiore della testa è presente un controllo "touch", che permette l'accensione, la regolazione dell'intensità luminosa e la selezione della temperatura di colore della luce tra 2200K, 2700K e 3000K. Grazie a un alto indice di protezione, la lampada è utilizzabile anche all'esterno (ad eccezione dei modelli con finitura galvanica, delle quali è sconsigliato l'uso continuativo in esterni). Possiede un sistema di controllo elettronico che monitora e segnala l'autonomia residua della batteria, permettendo di ottimizzare le ricariche ed effettuarle sempre in maniera corretta. È dotata di base di ricarica a contatto; caricabatterie non incluso.

Poldina micro is a rechargeable battery-powered cordless table lamp. A "touch" control on the head allows switching on/off, dimming, and selecting the color temperature of the light (2200K, 2700K or 3000K). It is suitable for both indoor and outdoor use (except gold and silver finishes). An electronic control system monitors the remaining autonomy and ensures a constant luminous flux until the battery runs out. Recharging is therefore optimized and always properly done. The lamp comes with a contact charging base; the battery charger is not included.

Dati tecnici Technical data

LED TOUCH DIMMER | 2200-2700-3000K | CRI>80 | 1,8W | 174-177-195lm |
IP65 | 5 Vdc max 1A



Corpo in pressofusione di alluminio verniciato
Painted die-cast aluminum body

Schermo diffusore in policarbonato
Polycarbonate diffuser

Adatta all'uso esterno (lampada IP65) e interno (lampada su base di ricarica IP20) → legenda pag. 208
Suitable for outdoor (lamp IP65) and indoor use (lamp on charging base IP20) → legend pg. 208

Durata di circa 7/8 h alla massima potenza
Battery lasts about 7/8 h at full power

Tempo di ricarica a 1A: 3 h
Charging time at 1A: 3 h

Pacco batteria al litio ricaricabile e sostituibile
Rechargeable and replaceable lithium battery pack

Avvertenze Remarks

Le lampade con finitura galvanica lucida oro e cromo non sono adatte per uso esterno.
The lamps with gold and chrome glossy galvanic finish are not suitable for outdoor use.

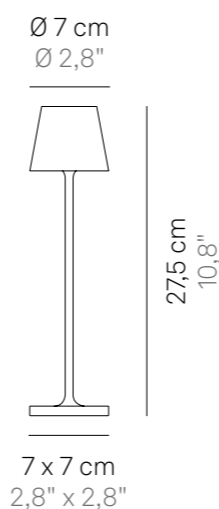

6,7 x 6,7 cm
2,6" x 2,6"

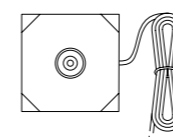

Componenti inclusi Components included

Base di ricarica a contatto
Contact charging base

Accessori non inclusi Accessories not included

Caricabatterie → pag. 199
Charger → pg. 199



Current page:
Poldina micro table lamp white → **LD0490B3**

Next page: Poldina micro
table lamp glossy gold → **LD049003**
Poldina table lamp white → **LD0340B3**



Finiture
Finishes



LD0490B3
Bianco / White
RAL 9003



LD0490R3
Corten



LD0490N3
Grigio scuro / Dark grey



LD0490D3
Nero / Black
RAL 9004



LD0490S3
Sabbia / Sand



LD0490G3
Salvia / Sage green
Pantone 5635 U



LD0490P3
Rosa / Pink
Pantone 698 U



LD0490F3
Rosso / Red
RAL 3000

Finiture
Finishes



LD0490K3
Blu Capri / Capri blue
RAL 5019



LD0490L3
Lilla / Lilac
RAL 4005



LD0490V3
Verde mela / Apple green
RAL 6018



LD0490Z3
Arancio / Orange
RAL 2008



LD0490O3 *
Oro lucido / Glossy gold



LD0490C3 *
Cromo lucido / Glossy chrome

* Le lampade con finitura galvanica lucida oro e cromo non sono adatte per uso esterno.
* The lamps with gold and chrome glossy galvanic finish are not suitable for outdoor use.

Poldina

Poldina micro

Tavolo pro
Table lamp pro



Video Poldina ↗



La finitura craquelé è realizzata tramite l'applicazione manuale di una foglia metallica color oro: questa lavorazione imita un disegno di screpolature superficiali, che rivelano il colore di fondo creando un gradevole contrasto cromatico e di texture.

Come le altre lampade portatili e ricaricabili già a catalogo, queste nuove versioni sono in alluminio pressofuso; si accendono, spengono e regolano con un tocco; si ricaricano con l'apposita base a contatto; permettono di scegliere la temperatura di colore della luce a LED tra 2200 K, 2700 K e 3000 K.

Adatte esclusivamente a uso interno.

The craquelé finish is created through the manual application of a gold-colored metal leaf: this process imitates a superficial pattern of cracks, which reveal the background color, creating a pleasing contrast in color and texture.

Just like the other portable and rechargeable lamps in the Zafferano catalog, these new versions are made of die-cast aluminum; they are turned on/off, and dimmed with a touch; they are recharged with a contact base; and they allow the user to choose the color temperature of the LED light between 2200 K, 2700 K, and 3000 K. The lamps are not suitable for outdoor use.



Poldina table lamp
red - gold color leaf → **LD034OFFO**



Poldina table lamp micro
Capri blue - gold color leaf → **LD0490KFO**
Poldina table lamp
Avio blue - gold color leaf → **LD0340AFO**



Poldina table lamp micro
black - gold color leaf → **LD0490DFO**

Dati tecnici

Technical data

LED TOUCH DIMMER

2200-2700-3000 K | CRI>80
234-251-256 lm | 2,2 W | IP65
50-60 Hz | 5 Vdc max 1A



Corpo in pressofusione di alluminio verniciato
Painted die-cast aluminum body

Schermo diffusore in policarbonato
Polycarbonate diffuser

Durata di circa 12 h alla massima potenza
Battery lasts about 12 h at full power

Tempo di ricarica a 1A: 6/7 h
Charging time at 1A: 6/7 h

Pacco batteria al litio ricaricabile e sostituibile
Rechargeable and replaceable lithium battery pack

Avvertenze

Remarks

Le lampade con finitura craquelé non sono adatte per uso esterno.
The lamps with craquelé finish are not suitable for outdoor use.

Per effetto della natura manuale della tecnica adottata nella lavorazione con foglia metallica, l'aspetto finale della finitura delle lampade può risultare differente. Eventuali difformità attestano il pregio e l'unicità di ciascuna lampada e non vanno considerate come imperfezioni.

Due to the manual nature of the technique adopted in the application of the metal foil, the final appearance of the lamps' finishing can be different. Any apparent imperfections attest to the quality and exclusivity of each lamp and should not be considered as imperfections.

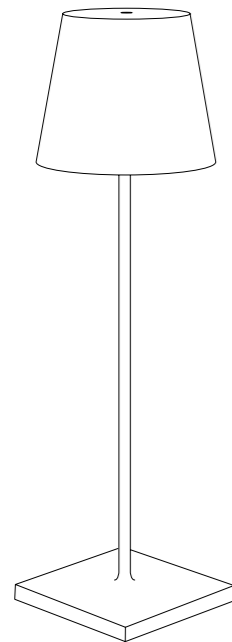

Ø 11 x 38 cm
Ø 4,3 x 15 in

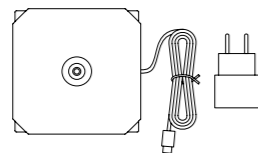

9,4 x 9,4 cm
3,7 x 3,7 in

Finiture

Finishes



LD0340DFO

Nero - Foglia color oro craquelé / Black - Gold color leaf
RAL 9004



LD0340AFO

Blu avio - Foglia color oro craquelé / Avio blue - Gold color leaf craquelé
Pantone 7468 U



LD0340FFO

Rosso - Foglia color oro craquelé / Red - Gold color leaf craquelé
RAL 3000

Componenti inclusi

Components included

Base di ricarica a contatto e caricatore
Contact charging base and charger

Dati tecnici

Technical data

LED TOUCH DIMMER

2200-2700-3000 K | CRI>80
174-177-195 lm | 1,8 W | IP65
5 Vdc max 1A



Corpo in pressofusione di alluminio verniciato
Painted die-cast aluminum body

Schermo diffusore in policarbonato
Polycarbonate diffuser

Durata di circa 7/8 h alla massima potenza
Battery lasts about 7/8 h at full power

Tempo di ricarica a 1A: 3 h
Charging time at 1A: 3 h

Pacco batteria al litio ricaricabile e sostituibile
Rechargeable and replaceable lithium battery pack

Avvertenze

Remarks

Le lampade con finitura craquelé non sono adatte per uso esterno.
The lamps with craquelé finish are not suitable for outdoor use.

Per effetto della natura manuale della tecnica adottata nella lavorazione con foglia metallica, l'aspetto finale della finitura delle lampade può risultare differente. Eventuali difformità attestano il pregio e l'unicità di ciascuna lampada e non vanno considerate come imperfezioni.

Due to the manual nature of the technique adopted in the application of the metal foil, the final appearance of the lamps' finishing can be different. Any apparent imperfections attest to the quality and exclusivity of each lamp and should not be considered as imperfections.

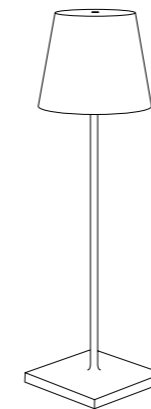

Ø 7 x 27,5 cm
Ø 2,8 x 10,8 in

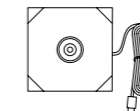

6,7 x 6,7 cm
2,6 x 2,6 in

Finiture

Finishes



LD0490DFO

Nero - Foglia color oro craquelé / Black - Gold color leaf
RAL 9004



LD0490KFO

Blu Capri - Foglia color oro craquelé / Capri blue - Gold color leaf craquelé
RAL 5019



LD0490FFO

Rosso - Foglia color oro craquelé / Red - Gold color leaf craquelé
RAL 3000

Componenti inclusi

Components included

Base di ricarica a contatto
Contact charging base

Accessori non inclusi

Accessories not included

Caricatore / Charger
100-240 V | USB Type A
LD0490UA

Poldina L desk

Tavolo pro Table lamp pro

NEW



Poldina L desk è una lampada da tavolo a batteria, portatile e ricaricabile. Nella parte superiore della testa è presente un controllo "touch", che permette l'accensione, la regolazione dell'intensità luminosa e la selezione della temperatura di colore della luce tra 2200K, 2700K e 3000K. Grazie a un alto indice di protezione, la lampada è utilizzabile anche all'esterno. Possiede un sistema di controllo elettronico che monitora e segnala l'autonomia residua della batteria, permettendo di ottimizzare le ricariche ed effettuarle sempre in maniera corretta. È dotata di base di ricarica a contatto; caricabatterie incluso.

Poldina L desk is a rechargeable battery-powered cordless table lamp. A "touch" control on the head allows switching on/off, dimming, and selecting the color temperature of the light (2200K, 2700K or 3000K). It is suitable for both indoor and outdoor use. An electronic control system monitors the remaining autonomy and ensures a constant luminous flux until the battery runs out. Recharging is therefore optimized and always properly done. The lamp comes with a contact charging base; the battery charger is included.

Poldina L desk table
lamp dark grey → **LD0395N3**



Dati tecnici

Technical data

LED TOUCH DIMMER | 100-240V | 2200-2700-3000K | CRI>80 | 50-60Hz | 5,5W | 479- 540-550lm | **IP54** | 5Vdc max 1A



Corpo in pressofusione di alluminio verniciato
Painted die-cast aluminum body

Schermo diffusore in policarbonato
Polycarbonate diffuser

Adatta all'uso esterno (lampada IP54) e interno (lampada su base di ricarica IP20) → legenda pag. 208
Suitable for outdoor (lamp IP54) and indoor use (lamp on charging base IP20) → legend pg. 208

Durata di circa 11 h alla massima potenza
Battery lasts about 11 h at full power

Tempo di ricarica a 1A: 11 h
Charging time at 1A: 11 h

Pacco batteria al litio ricaricabile e sostituibile
Rechargeable and replaceable lithium battery pack

Ø 16,5 cm
Ø 6,5"

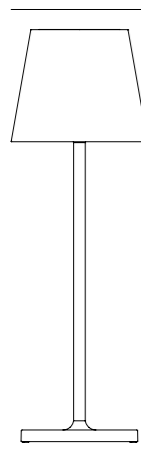

49,7 cm
19,6"

14 x 14 cm
5,5" x 5,5"

13,5 x 13,5 cm
5,3" x 5,3"

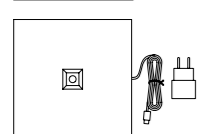
**Componenti inclusi**

Components included

Base di ricarica a contatto
Contact charging base

Caricabatterie
Charger

Finiture

Finishes



LD0395B3
Bianco / White
RAL 9003

LD0395R3
Corten

LD0395N3
Grigio scuro / Dark grey



Poldina L

Tavolo-terra pro Floor-table lamp pro



Poldina L è una lampada da terra e da tavolo a batteria, portatile e ricaricabile. Nella parte superiore della testa è presente un controllo "touch", che permette l'accensione, la regolazione dell'intensità luminosa e la selezione della temperatura di colore della luce tra 2200K, 2700K e 3000K. Grazie a un alto indice di protezione, la lampada è utilizzabile anche all'esterno. Possiede un sistema di controllo elettronico che monitora e segnala l'autonomia residua della batteria, permettendo di ottimizzare le ricariche ed effettuarle sempre in maniera corretta. È dotata di base di ricarica a contatto; caricabatterie incluso. È fornita con un kit di 3 aste che permette di configurarne l'altezza in tre misure: 52, 87 o 122 cm.

Poldina L is a rechargeable battery-powered cordless floor and table lamp. A "touch" control on the head allows switching on/off, dimming, and selecting the color temperature of the light (2200K, 2700K or 3000K). It is suitable for both indoor and outdoor use. An electronic control system monitors the remaining autonomy and ensures a constant luminous flux until the battery runs out. Recharging is therefore optimized and always properly done. The lamp comes with a contact charging base; the battery charger is included. It is provided with a 3-rod kit that allows to choose the height of the lamp among 52, 87 or 122 cm.

Poldina L floor-table lamp
white → **LD0390B3**



Dati tecnici

Technical data

LED TOUCH DIMMER | 100-240V | 2200-2700-3000K | CRI>80 | 50-60Hz | 5,5W | 479-540-550lm | **IP54** | 5Vdc max 1A



Ø 16,5 cm
Ø 6,5"

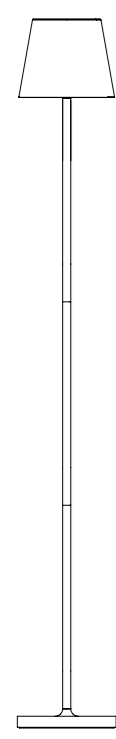

122 cm
48"

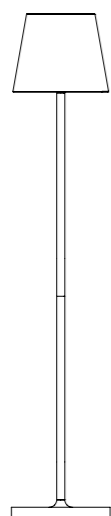

87 cm
34,2"

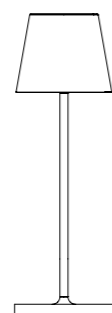

52 cm
20,4"

17 x 17 cm
6,6" x 6,6"

15 x 15 cm
5,9" x 5,9"

35 cm
13,8"

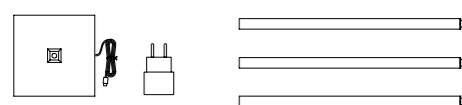

Corpo in pressofusione di alluminio verniciato

Painted die-cast aluminum body

Schermo diffusore in policarbonato

Polycarbonate diffuser

Adatta all'uso esterno (lampada IP54) e interno (lampada su base di ricarica IP20) → legenda pag. 208

Suitable for outdoor (lamp IP54) and indoor use (lamp on charging base IP20) → legend pg. 208

Durata di circa 11 h alla massima potenza

Battery lasts about 11 h at full power

Tempo di ricarica a 1A: 11 h

Charging time at 1A: 11 h

Pacco batteria al litio ricaricabile e sostituibile

Rechargeable and replaceable lithium battery pack

Finiture

Finishes



LD0390B3
Bianco / White
RAL 9003



LD0390R3
Corten



LD0390N3
Grigio scuro / Dark grey

Poldina XXL

Tavolo-terra pro Floor-table lamp pro



Poldina XXL è una lampada da terra e da tavolo a batteria, portatile e ricaricabile. Nella parte superiore dello stelo è presente un controllo "touch", che permette l'accensione, la regolazione dell'intensità luminosa e la selezione della temperatura di colore della luce tra 2700K e 3000K. Grazie a un alto indice di protezione, la lampada è utilizzabile anche all'esterno. È dotata di base di ricarica a contatto; caricabatterie incluso. È fornita con un kit di 3 aste che permette di configurarne l'altezza in tre misure: 69, 110 o 150 cm.

Poldina XXL is a rechargeable battery-powered cordless floor and table lamp. A "touch" control on the upper part of the stem allows switching on/off, dimming, and selecting the color temperature of the light (2700K or 3000K). It is suitable for both indoor and outdoor use. The lamp comes with a contact charging base; the battery charger is included. It is provided with a 3-rod kit that allows to choose the height of the lamp among 69, 110 or 150 cm.



Poldina XXL floor-table lamp
dark grey → **LD0360N3**

Dati tecnici

Technical data

LED TOUCH DIMMER | 100-240V |
2700-3000K | CRI>80 | 50-60Hz | 6,5W |
470-500lm | **IP54** | 5Vdc max 1A



Ø 28 cm
Ø 11"

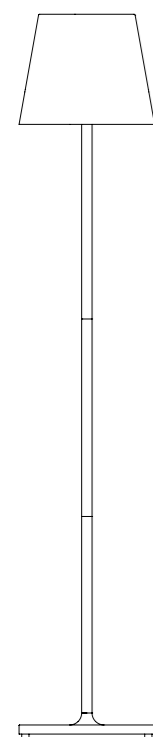

150 cm
59"

28 x 28 cm
11" x 11"

Ø 24,7 cm
Ø 9,7"

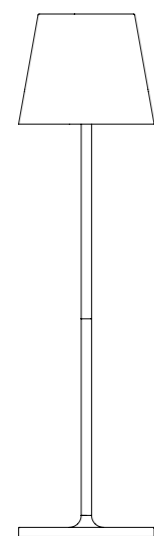
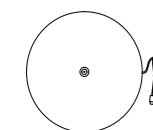

110 cm
43,3"

40 cm
15,7"

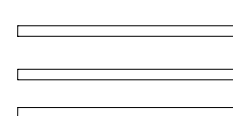

Corpo in pressofusione di alluminio verniciato
Painted die-cast aluminum body

Schermo diffusore in policarbonato
Polycarbonate diffuser

Adatta all'uso esterno (lampada IP54) e interno
(lampada su base di ricarica IP20) → legenda pag. 208
Suitable for outdoor (lamp IP54) and indoor use
(lamp on charging base IP20) → legend pg. 208

Durata di circa 15 h alla massima potenza
Battery lasts about 15 h at full power

Tempo di ricarica a 1A: 20 h
Charging time at 1A: 20 h

Pacco batteria al litio ricaricabile e sostituibile
Rechargeable and replaceable lithium battery pack

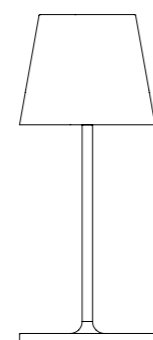

69,5 cm
27,3"

Componenti inclusi

Components included

Base di ricarica a contatto
Contact charging base

Caricabatterie
Charger

Stelo (3 pz.)
Stem (3 pcs.)

Finiture

Finishes



LD0360B3
Bianco / White
RAL 9003

LD0360R3
Corten

LD0360N3
Grigio scuro / Dark grey

Poldina

Picchetto pro

Lamp with peg pro



Poldina è una lampada a batteria, portatile e ricaricabile con picchetto. Nella parte superiore della testa è presente un controllo "touch", che permette l'accensione, la regolazione dell'intensità luminosa e la selezione della temperatura di colore della luce tra 2200K, 2700K e 3000K. Grazie a un alto indice di protezione, la lampada è utilizzabile anche all'esterno. Possiede un sistema di controllo elettronico che monitora e segnala l'autonomia residua della batteria, permettendo di ottimizzare le ricariche ed effettuarle sempre in maniera corretta. È dotata di testa magnetica che si rimuove in modo pratico e si ricarica comodamente sulla propria base di ricarica a contatto; caricabatterie incluso. È possibile personalizzare la lampada con cover in ceramica, acquistabili separatamente. Come accessori, sono disponibili aste aggiuntive che permettono di aumentare l'altezza della lampada.

Poldina is a rechargeable battery-powered cordless lamp with peg. A "touch" control on the head allows switching on/off, dimming, and selecting the color temperature of the light (2200K, 2700K or 3000K). It is suitable for both indoor and outdoor use. An electronic control system monitors the remaining autonomy and ensures a constant luminous flux until the battery runs out. Recharging is therefore optimized and always properly done. The lamp comes with magnetic head, which can be removed easily and recharged conveniently on their own contact charging base; the battery charger is included. It can be customized with a ceramic cover, to be purchased separately. Additional stem extensions are available as accessories to increase the height of the lamp (to be purchased separately).

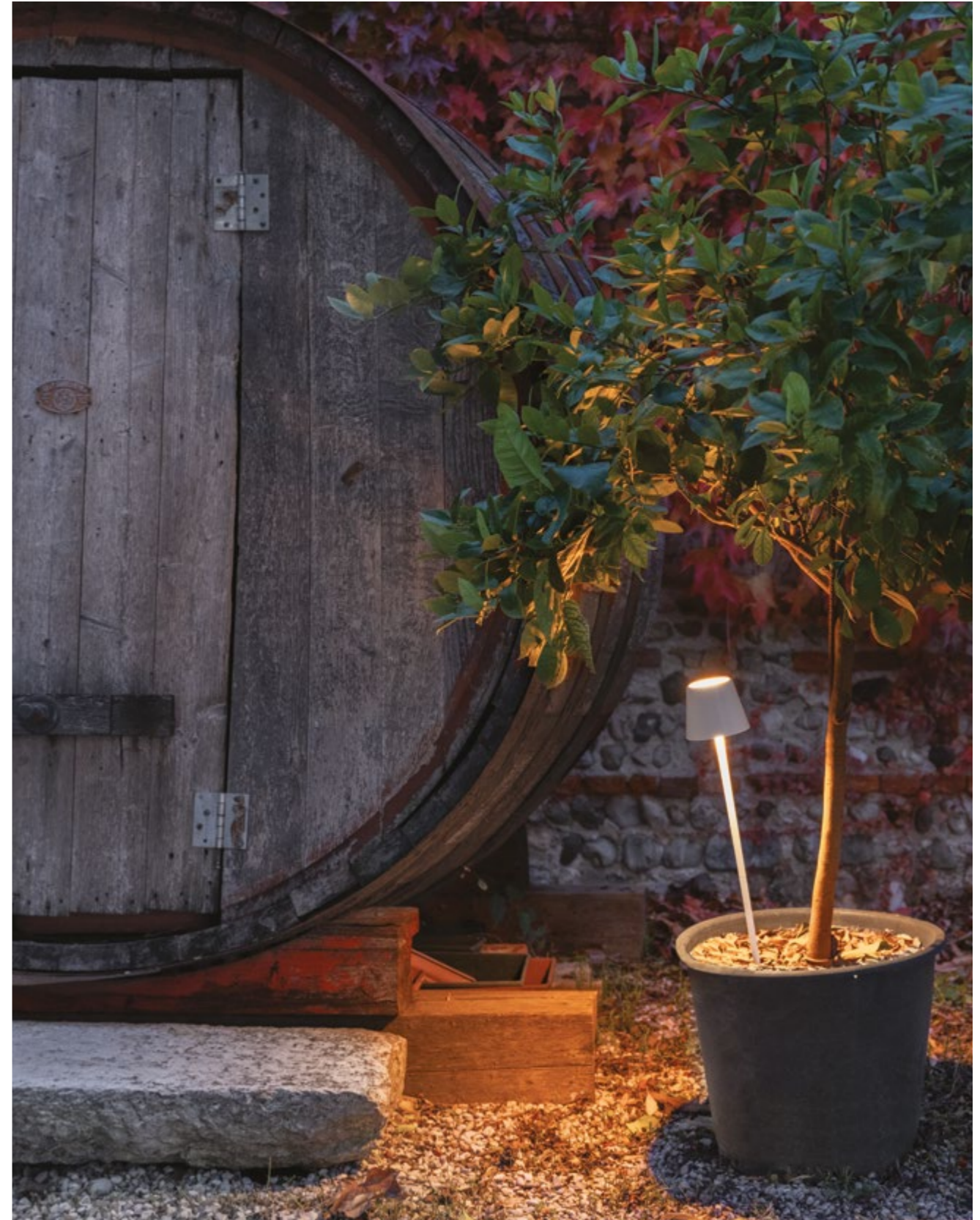

Poldina lamp with peg white → **LD0682B3**

Dati tecnici

Technical data

LED TOUCH DIMMER | 100-240V | 2200-2700-3000K | CRI>80 | 50-60Hz | 2,2W | 234-251-256lm | **IP54** | 5Vdc max 1A



Corpo in pressofusione di alluminio verniciato

Painted die-cast aluminum body

Schermo diffusore in policarbonato

Polycarbonate diffuser

Adatta all'uso esterno (lampada IP54) e interno (lampada su base di ricarica IP20) → legenda pag. 208

Suitable for outdoor (lamp IP54) and indoor use (lamp on charging base IP20) → legend pg. 208

Durata di circa 9 h alla massima potenza

Battery lasts about 9 h at full power

Tempo di ricarica a 1A: 6 h

Charging time at 1A: 6 h

Pacco batteria al litio ricaricabile e sostituibile

Rechargeable and replaceable lithium battery pack

Avvertenze

Remarks

La stabilità della lampada è garantita con l'uso di massimo tre prolunghe

The stability of the lamp is guaranteed when using three extensions maximum

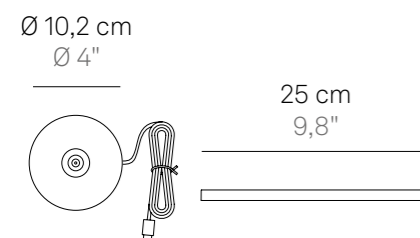
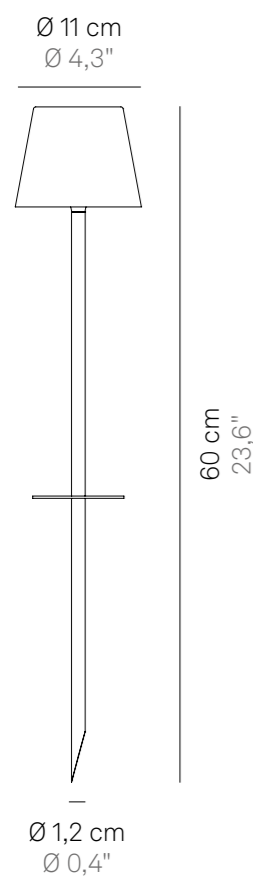
**Componenti inclusi**

Components included

Base di ricarica a contatto
Contact charging base

Stelo (1 pz.)
Stem (1 pc.)

Accessori non inclusi

Accessories not included

Caricabatterie → pag. 199
Charger → pg. 199

Prolunga stelo aggiuntiva → pag. 45
Additional stem extension → pg. 45

Finiture

Finishes

**LD0682B3**

Bianco / White
RAL 9003

LD0682R3

Corten

LD0682N3

Grigio scuro / Dark grey

Prolunga stelo aggiuntiva (non inclusa)

Additional stem extension (not included)

**LD0283B3**

Bianco / White
RAL 9003

LD0283R3

Corten

LD0283N3

Grigio scuro / Dark grey

Poldina

Sospensione pro Suspension lamp pro



Poldina è una lampada a batteria, portatile e ricaricabile a sospensione. Nella parte superiore della testa è presente un controllo "touch", che permette l'accensione, la regolazione dell'intensità luminosa e la selezione della temperatura di colore della luce tra 2200K, 2700K e 3000K. Grazie a un alto indice di protezione, la lampada è utilizzabile anche all'esterno. Possiede un sistema di controllo elettronico che monitora e segnala l'autonomia residua della batteria, permettendo di ottimizzare le ricariche ed effettuarle sempre in maniera corretta. È dotata di testa magnetica che si rimuove in modo pratico e si ricarica comodamente sulla propria base di ricarica a contatto; caricabatterie incluso. È possibile personalizzare la lampada con cover in ceramica, acquistabili separatamente. Come accessori, sono disponibili aste aggiuntive che permettono di aumentare l'altezza della lampada.

Poldina is a rechargeable battery-powered cordless suspension lamp. A "touch" control on the head allows switching on/off, dimming, and selecting the color temperature of the light (2200K, 2700K or 3000K). It is suitable for both indoor and outdoor use. An electronic control system monitors the remaining autonomy and ensures a constant luminous flux until the battery runs out. Recharging is therefore optimized and always properly done. The lamp comes with magnetic head, which can be removed easily and recharged conveniently on their own contact charging base; the battery charger is included. It can be customized with a ceramic cover, to be purchased separately. Additional stem extensions are available as accessories to increase the height of the lamp (to be purchased separately).

Poldina suspension lamp
white → **LD0686B3**



Dati tecnici

Technical data

LED TOUCH DIMMER | 100-240V | 2200-2700-3000K | CRI>80 | 50-60Hz | 2,2W | 234-251-256lm | **IP54** | 5Vdc max 1A



Corpo in pressofusione di alluminio verniciato

Painted die-cast aluminum body

Schermo diffusore in policarbonato

Polycarbonate diffuser

Adatta all'uso esterno (lampada IP54) e interno (lampada su base di ricarica IP20) → legenda pag. 208

Suitable for outdoor (lamp IP54) and indoor use (lamp on charging base IP20) → legend pg. 208

Durata di circa 9 h alla massima potenza

Battery lasts about 9 h at full power

Tempo di ricarica a 1A: 6 h

Charging time at 1A: 6 h

Pacco batteria al litio ricaricabile e sostituibile

Rechargeable and replaceable lithium battery pack

Ø 11 cm
Ø 4,3"

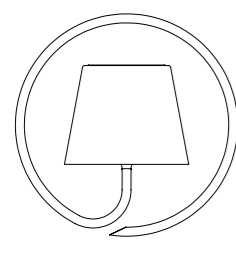

19,8 cm
7,8"

19,8 cm
7,8"

Ø 10,2 cm
Ø 4"

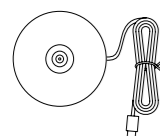
**Componenti inclusi**

Components included

Base di ricarica a contatto
Contact charging base

Accessori non inclusi

Accessories not included

Caricabatterie → pag. 199

Charger → pg. 199

Finiture

Finishes

**LD0686B3**

Bianco / White

RAL 9003

LD0686R3

Corten

LD0686N3

Grigio scuro / Dark grey



Poldina suspension lamp
corten → **LD0686R3**

Poldina

Parete pro Wall lamp pro



Poldina è una lampada a batteria, portatile e ricaricabile da parete, disponibile in due versioni. Nella parte superiore della testa è presente un controllo "touch", che permette l'accensione, la regolazione dell'intensità luminosa e la selezione della temperatura di colore della luce tra 2200K, 2700K e 3000K. Grazie a un alto indice di protezione, la lampada è utilizzabile anche all'esterno. Possiede un sistema di controllo elettronico che monitora e segnala l'autonomia residua della batteria, permettendo di ottimizzare le ricariche ed effettuarle sempre in maniera corretta. È dotata di testa magnetica che si rimuove in modo pratico e si ricarica comodamente sulla propria base di ricarica a contatto; caricabatterie incluso. È possibile personalizzare la lampada con cover in ceramica, acquistabili separatamente. Come accessori, sono disponibili aste aggiuntive che permettono di aumentare l'altezza della lampada.

Poldina is a rechargeable battery-powered cordless wall lamp. A "touch" control on the head allows switching on/off, dimming, and selecting the color temperature of the light (2200K, 2700K or 3000K). It is suitable for both indoor and outdoor use. An electronic control system monitors the remaining autonomy and ensures a constant luminous flux until the battery runs out. Recharging is therefore optimized and always properly done. The lamp comes with magnetic head, which can be removed easily and recharged conveniently on their own contact charging base; the battery charger is included. It can be customized with a ceramic cover, to be purchased separately. Additional stem extensions are available as accessories to increase the height of the lamp (to be purchased separately).



Poldina wall lamp dark grey
→ LD0688N3

Dati tecnici

Technical data

LED TOUCH DIMMER | 100-240V | 2200-2700-3000K | CRI>80 | 50-60Hz | 2,2W | 234-251-256lm | **IP54** | 5Vdc max 1A

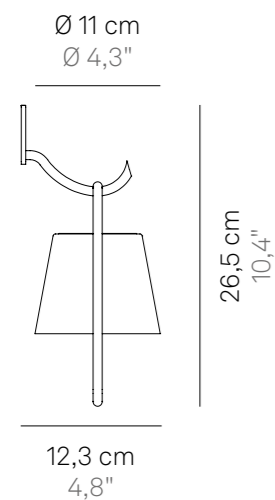
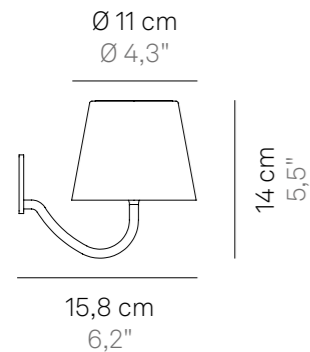

Ø 10,2 cm
Ø 4"

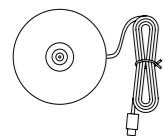

Componenti inclusi
Components included

Base di ricarica a contatto
Contact charging base

Corpo in pressofusione di alluminio verniciato
Painted die-cast aluminum body

Schermo diffusore in policarbonato
Polycarbonate diffuser

Adatta all'uso esterno (lampada IP54) e interno (lampada su base di ricarica IP20) → legenda pag. 208
Suitable for outdoor (lamp IP54) and indoor use (lamp on charging base IP20) → legend pg. 208

Durata di circa 9 h alla massima potenza
Battery lasts about 9 h at full power

Tempo di ricarica a 1A: 6 h
Charging time at 1A: 6 h

Pacco batteria al litio ricaricabile e sostituibile
Rechargeable and replaceable lithium battery pack

Accessori non inclusi
Accessories not included

Caricabatterie → pag. 199
Charger → pg. 199

Finiture

Finishes



LD0688B3
Bianco / White
RAL 9003



LD0688R3
Corten



LD0688N3
Grigio scuro / Dark grey



LD0689B3
Bianco / White
RAL 9003



LD0689R3
Corten



LD0689N3
Grigio scuro / Dark grey

Poldina

Cover in ceramica made in Italy

Ceramic cover made in Italy

NEW

Accessorio per / Accessory for:
 Poldina table lamp (pg. 12)
 Poldina mini table lamp (pg. 20)
 Poldina lamp with peg (pg. 42)
 Poldina suspension lamp (pg. 46)
 Poldina wall lamp (pg. 50)
 Poldina Reverso table lamp (pg. 60)



Dati tecnici

Technical data

CE

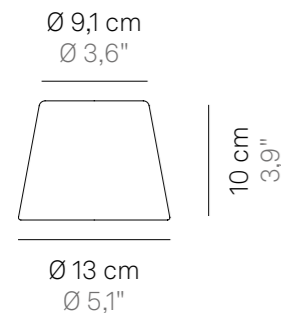

Componenti inclusi
 Components included

Magnete
 Magnet

Video tutorial: montaggio cover
 Tutorial video: installation of the cover



Cover in ceramica che si fissa alla testa della lampada Poldina tramite adesivi. La stretta collaborazione con un'antica fabbrica di Civita Castellana - borgo viterbese dove l'arte della ceramica è attestata fin dal X secolo a.C. – consente a Zafferano di avvalersi di una produzione esclusiva di manufatti “Made in Italy”, decorati a mano su disegno proprio o del cliente.

Ceramic cover that is fixed to the head of the lamp with adhesive strips. The close partnership with a historic factory in Civita Castellana - a village near Rome, where the art of ceramics has been practiced since the 10th century BC - allows Zafferano to rely on the exclusive production of made in Italy artifacts, which are hand-painted according to Zafferano design; customization available.

Finiture
 Finishes



LD035000
 Righe verdi
 Green stripes



LD035001
 Righe gialle
 Yellow stripes



LD035002
 Righe blu
 Blue stripes



LD035003
 Righe rosse
 Red stripes



LD035004
 Pesci azzurri
 Light blue fish



Poldina table lamp Avio blue → LD0340A3
 Ceramic cover → LD035004



Poldina wall lamp white + ceramic cover
→ **LD0340B3** + **LD035000**

