

PINZA SELECCIONADORA MB-G1200 S4

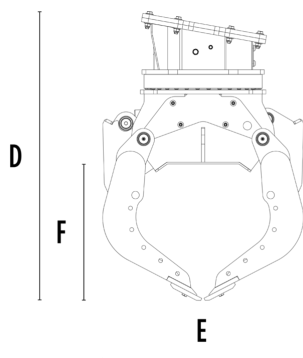
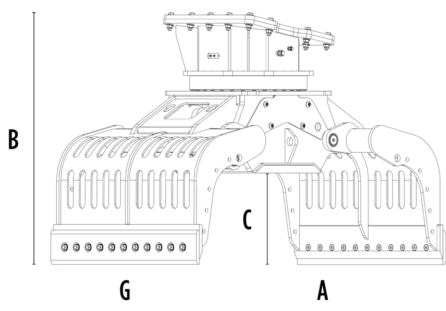

CARACTERÍSTICAS TÉCNICAS

Excavadora aconsejada	lb	39,680 - 66,140
Peso	lb	3,637
Capacidad (garras cerradas)	cy	0.93
Rotación	Degree	360°
Presión del aceite (rotación)	PSI	2,901 - 3,626
Caudal de aceite (rotación)	gal/min	8 - 11
Presión de aceite máxima (apertura - cierre)	PSI	4,351 - 5,076
Caudal de aceite máximo (apertura - cierre)	gal/min	18 - 24
Dimensión A	in	83
Dimensión B	in	57
Dimensión C	in	23
Dimensión D	in	66
Dimensión E	in	47
Dimensión F	in	32
Dimensión G	in	49

ACCESORIOS OPCIONALES

Kit cuchillas multifunción	Kit de cobertura para contención de garras
Kit para mejorar el agarre interno de las garras	Kit de elevación basculante con perfiles de goma
Kit multiplicador de fuerza de rotación	Kit eléctrico (para funcionalidad dos tubos) 12 V
Remote power control system	

ÁREAS DE APLICACIÓN



Demoliciones



Obras viales



Canteras



Minas



Galerías



Ambientes cerrados



Canalizaciones



Obras urbanas



Mantenimiento de áreas verdes y agrícolas



Mantenimiento de áreas forestales

