

SORTING GRAPPLE

MB-G900 S4

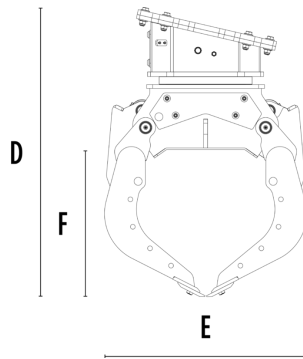
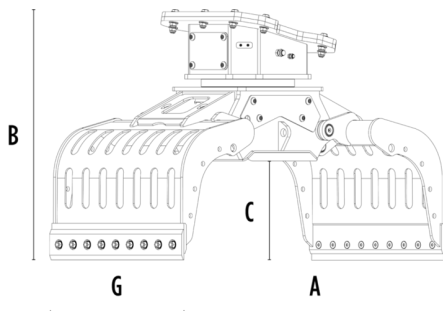

SPECIFICATIONS

Recommended excavator	ton	12 - 18
Weight	ton	0,78
Capacity (claws closed)	m ³	0,43
Rotation	Degree	360°
Oil pressure (rotation)	bar	160 - 220
Oil flow rate (rotation)	l/min	25 - 35
Maximum oil pressure (opening - closing)	bar	300 - 350
Maximum oil flow rate (opening - closing)	l/min	60 - 70
Size A	mm	1860
Size B	mm	1210
Size C	mm	540
Size D	mm	1410
Size E	mm	1000
Size F	mm	740
Size G	mm	930

OPTIONAL ACCESSORIES

Multi-purpose blade kit	Clam shell kit
Serrated side plate kit	Grip improvement kit
Rubber protection kit	Rotation power extender kit
Electrical kit (for 2 hose functionality) 12 V	Remote power control system
24 Month warranty	

APPLICATION AREAS



Demolitions



Road works



Quarry



Mines



Tunnels



Enclosed spaces



Pipelines



Urban construction site



Maintaining landscape and agricultural areas



Forest Maintenance

